

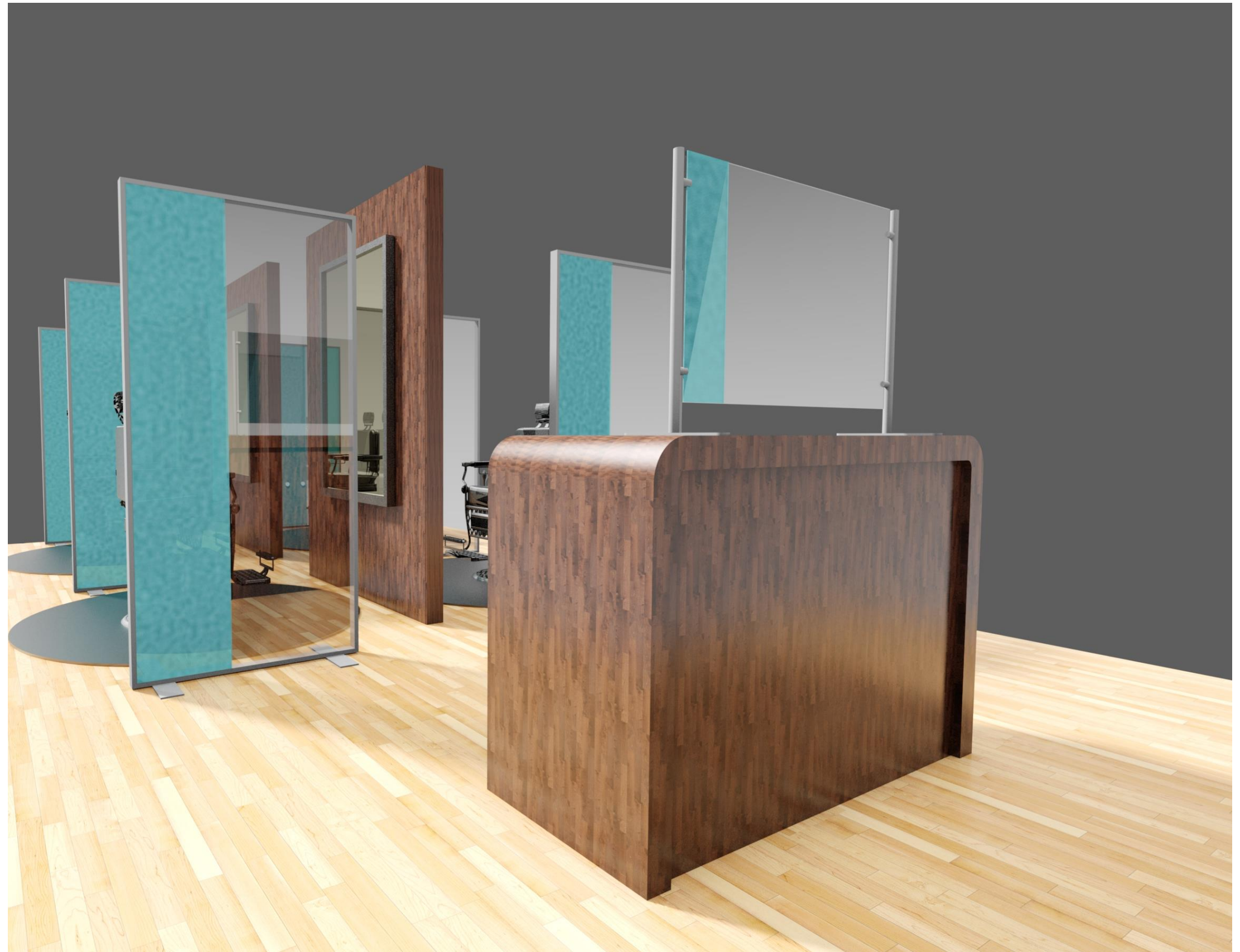

Salon Reopen

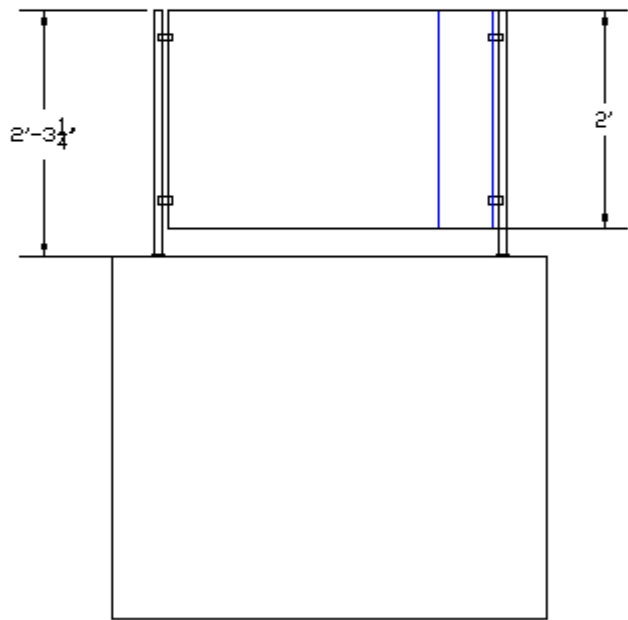

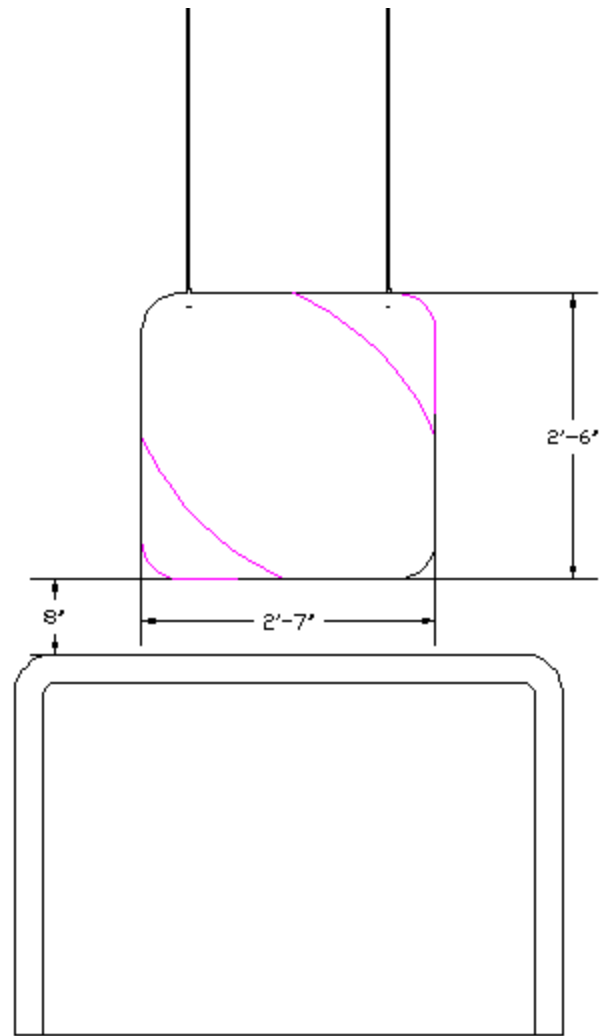

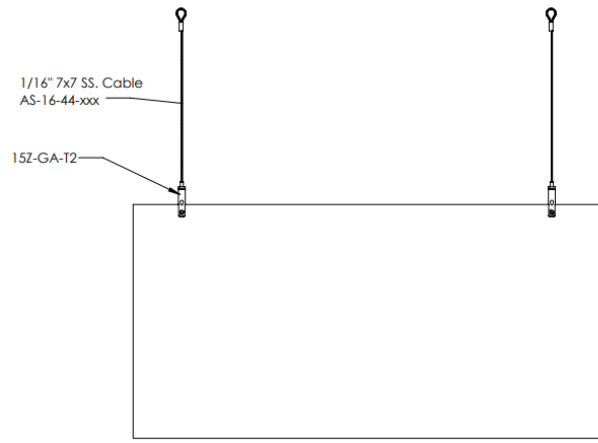



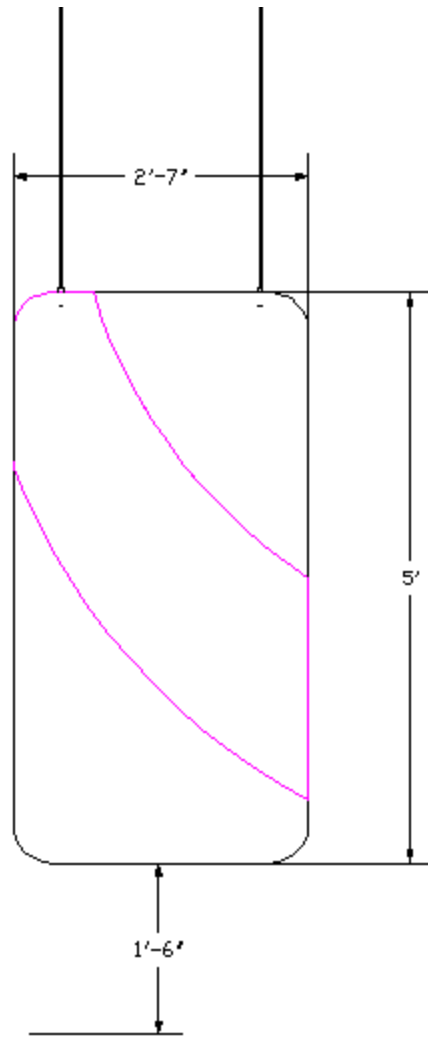
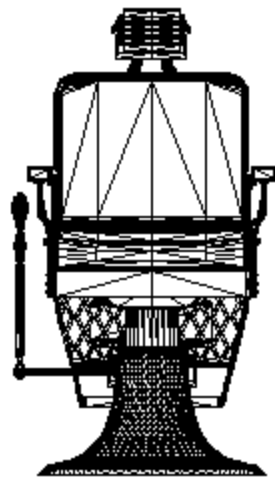

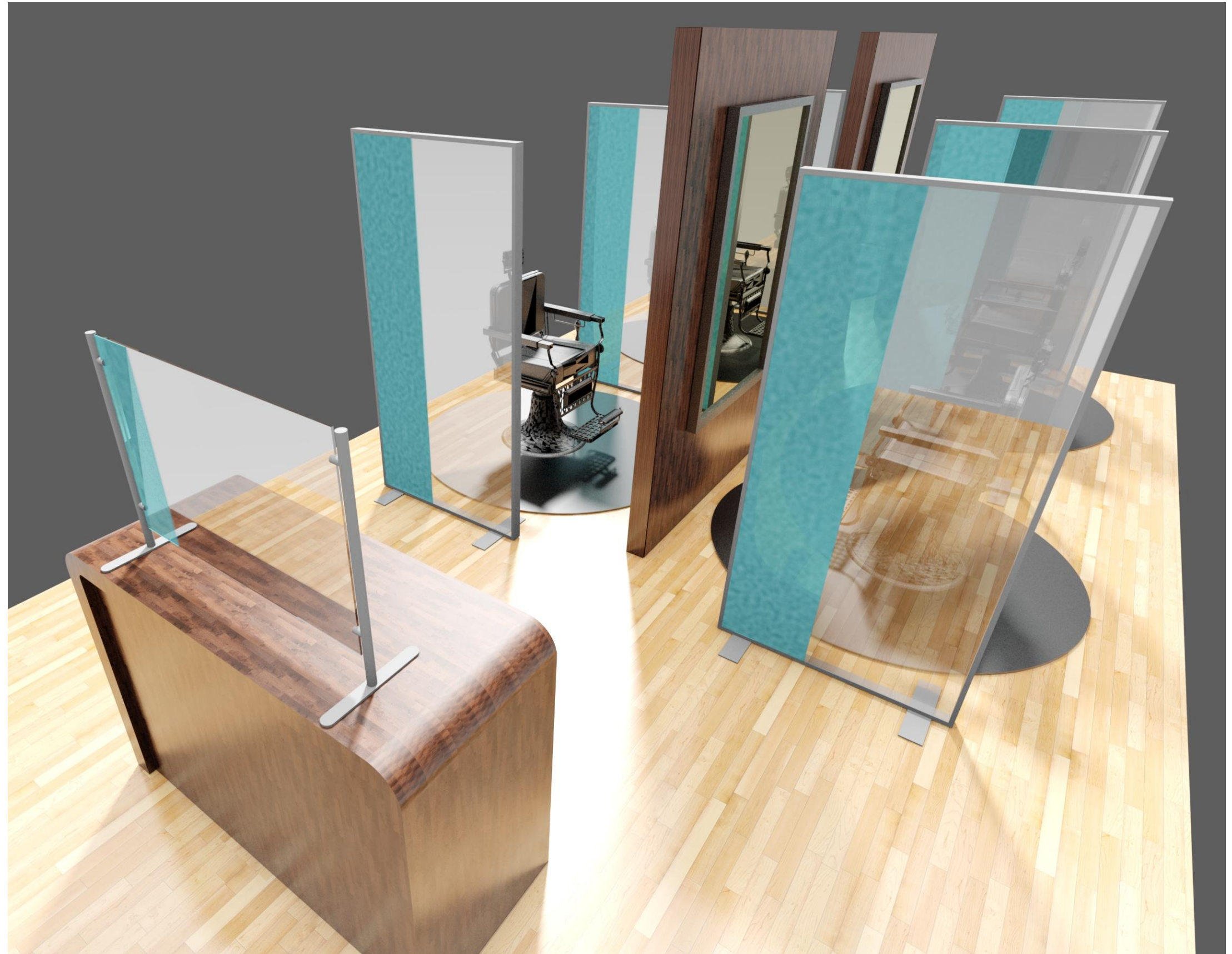
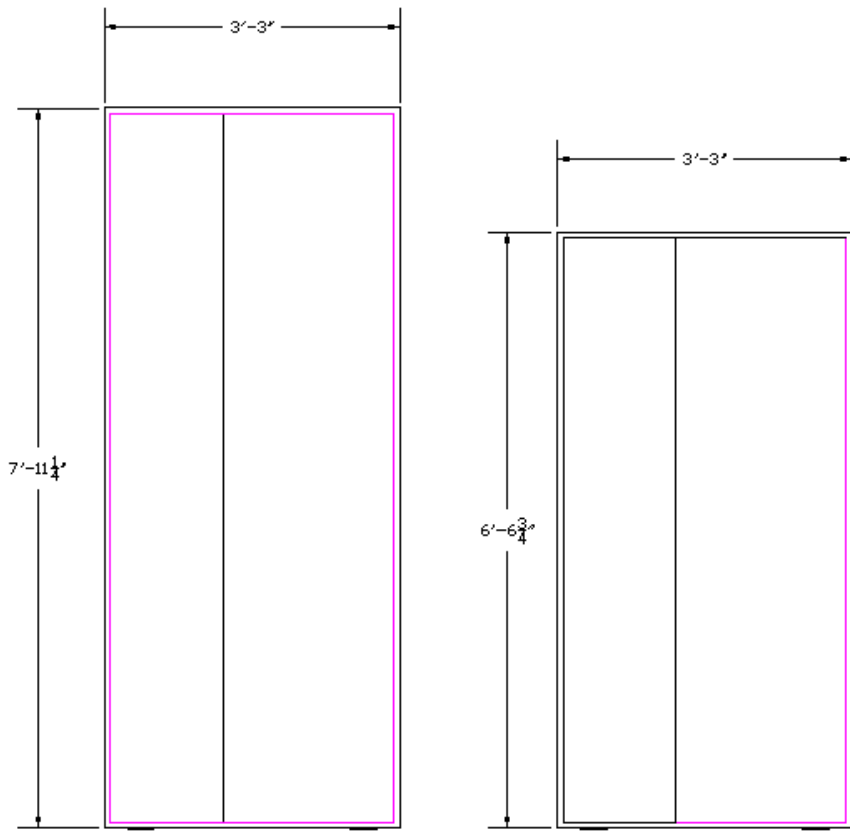

Suspended clear plexi

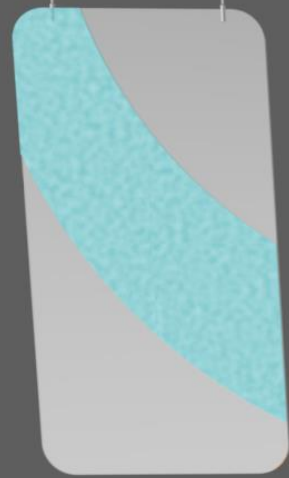

Aluminum extrusion w/
clear plexi insert &
colored vinyl

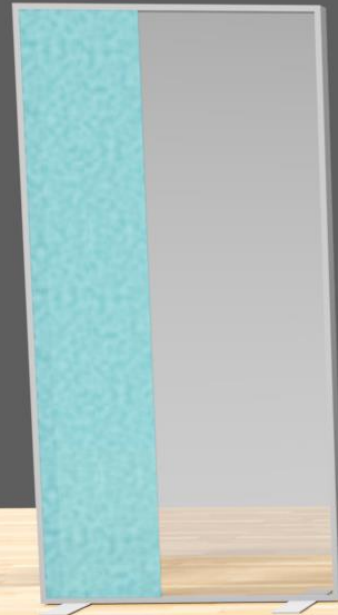

Aluminum tube
structure with clear vinyl
back and front



Aluminum tube
structure with
printed graphic



Aluminum tube
structure with
Upholstered front
and back

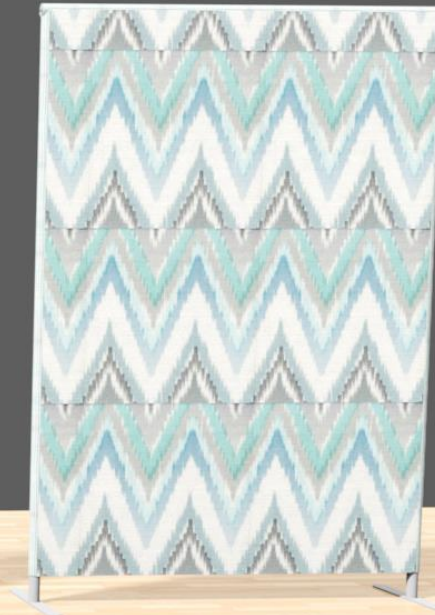

Aluminum tube
structure with
Hanging Marine Vinyl

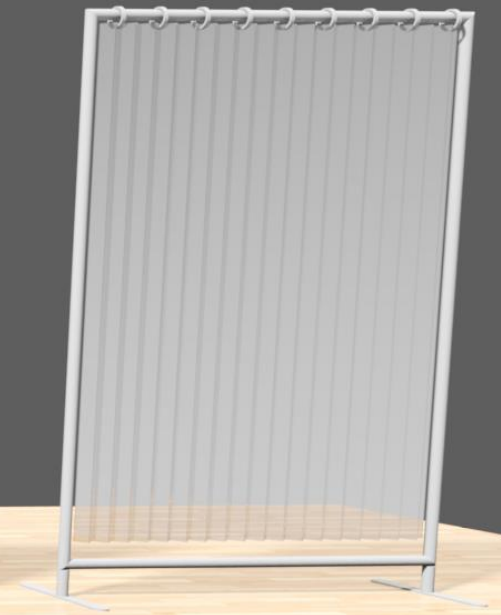

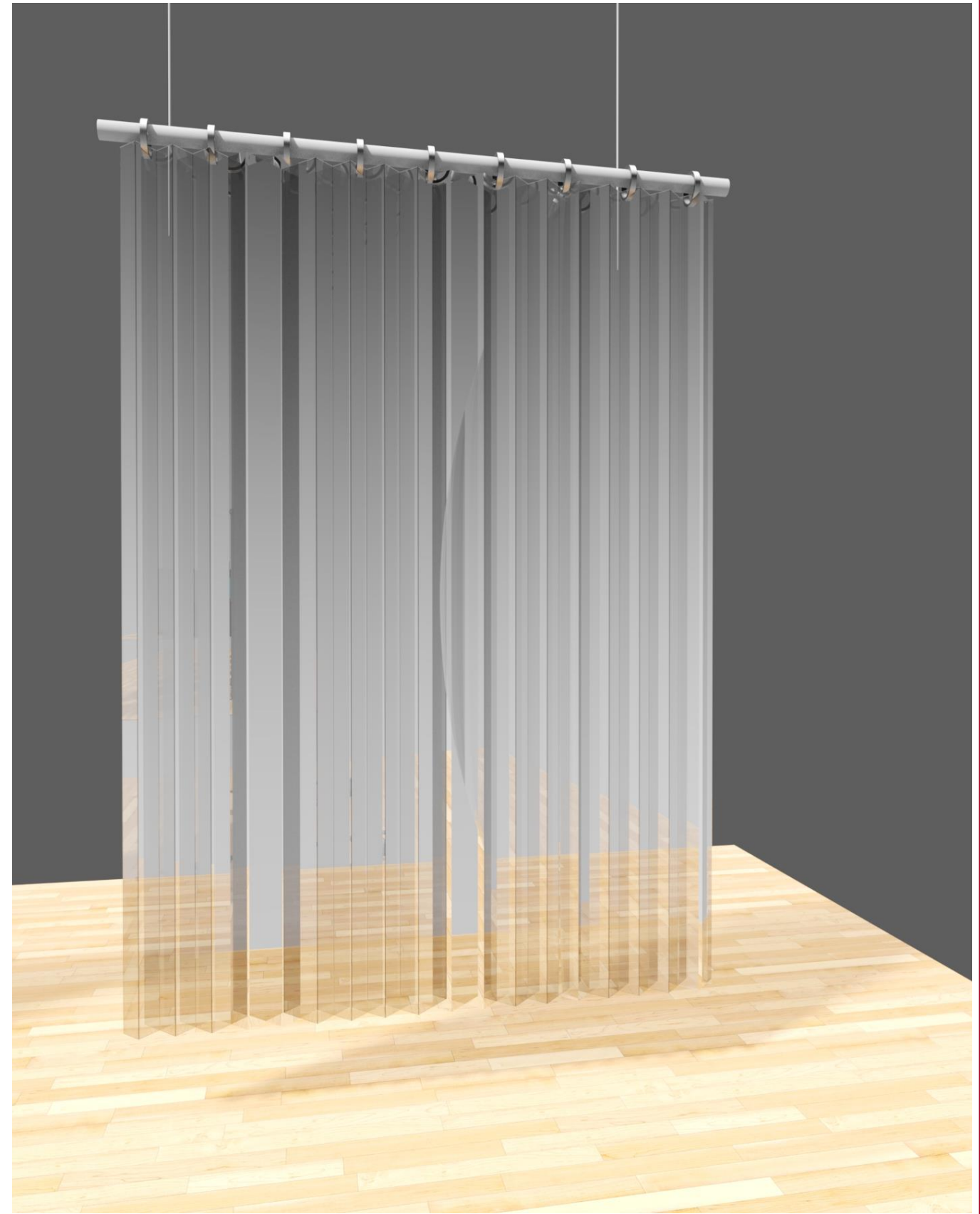





Clear Desktop hygiene shields



Clear hanging hygiene shields

Floor graphics

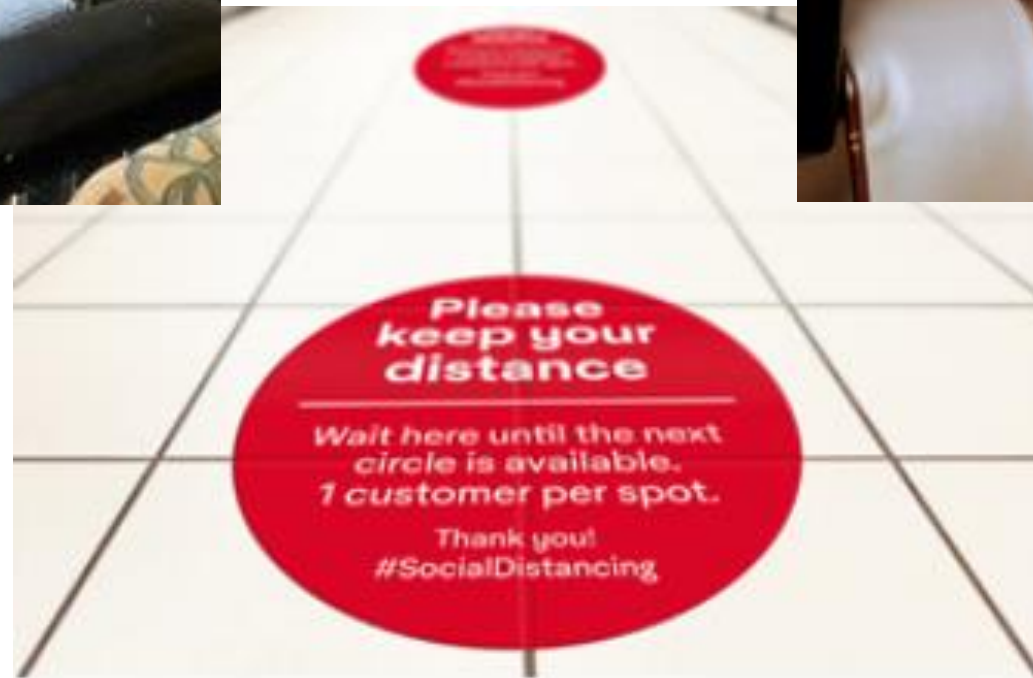



Lounge and Office Partitions

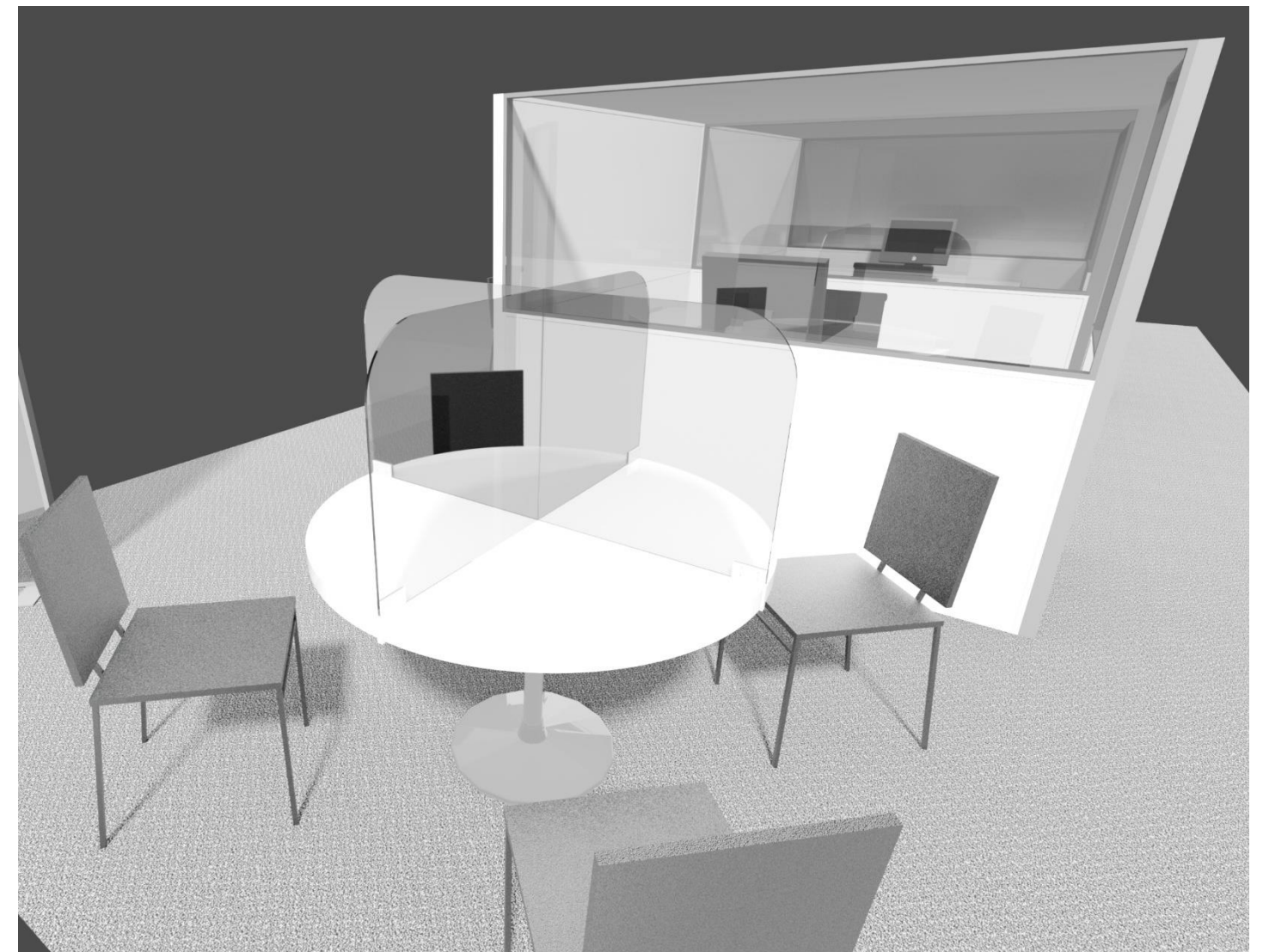

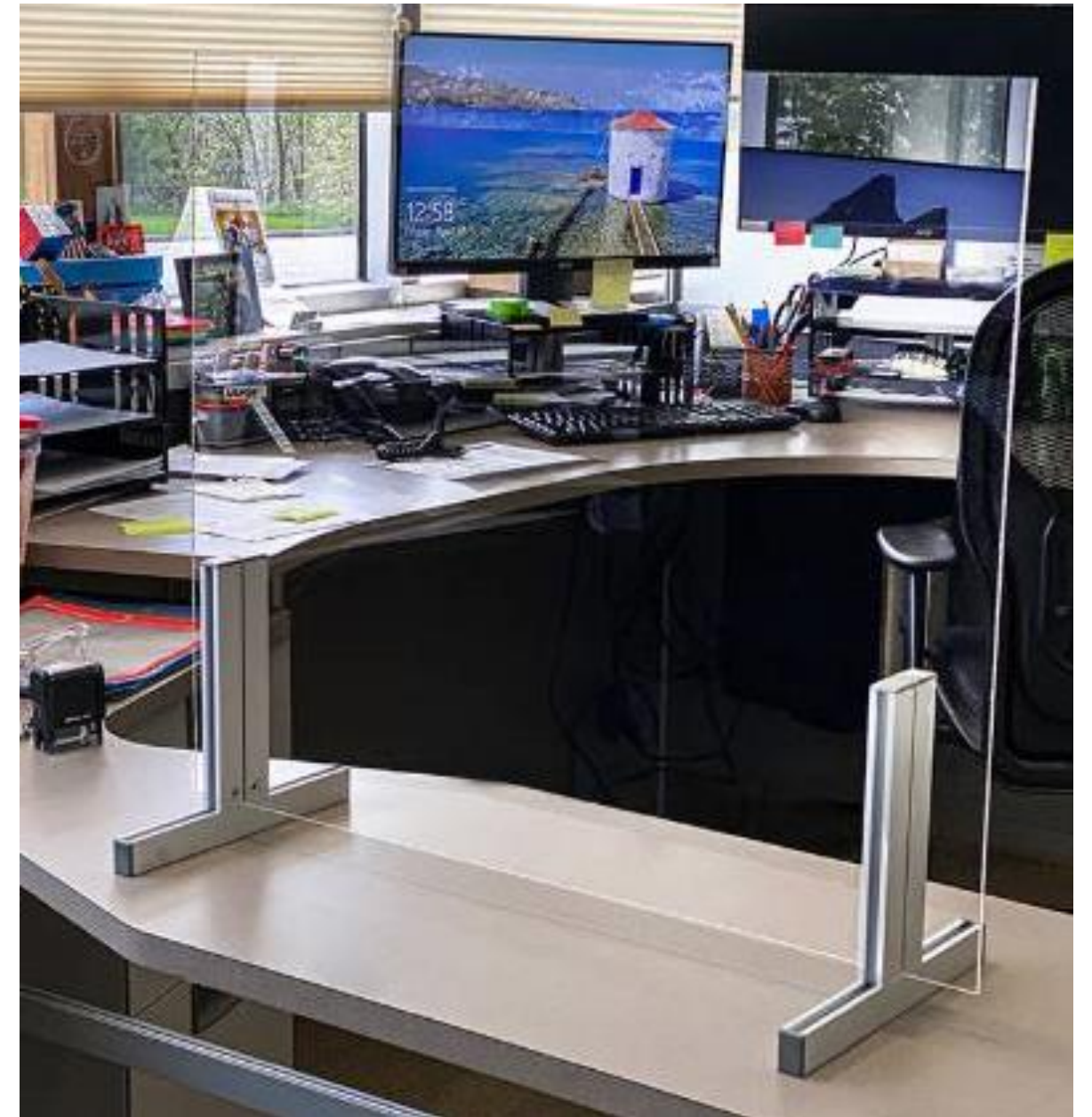

Reception Partitions



Clear

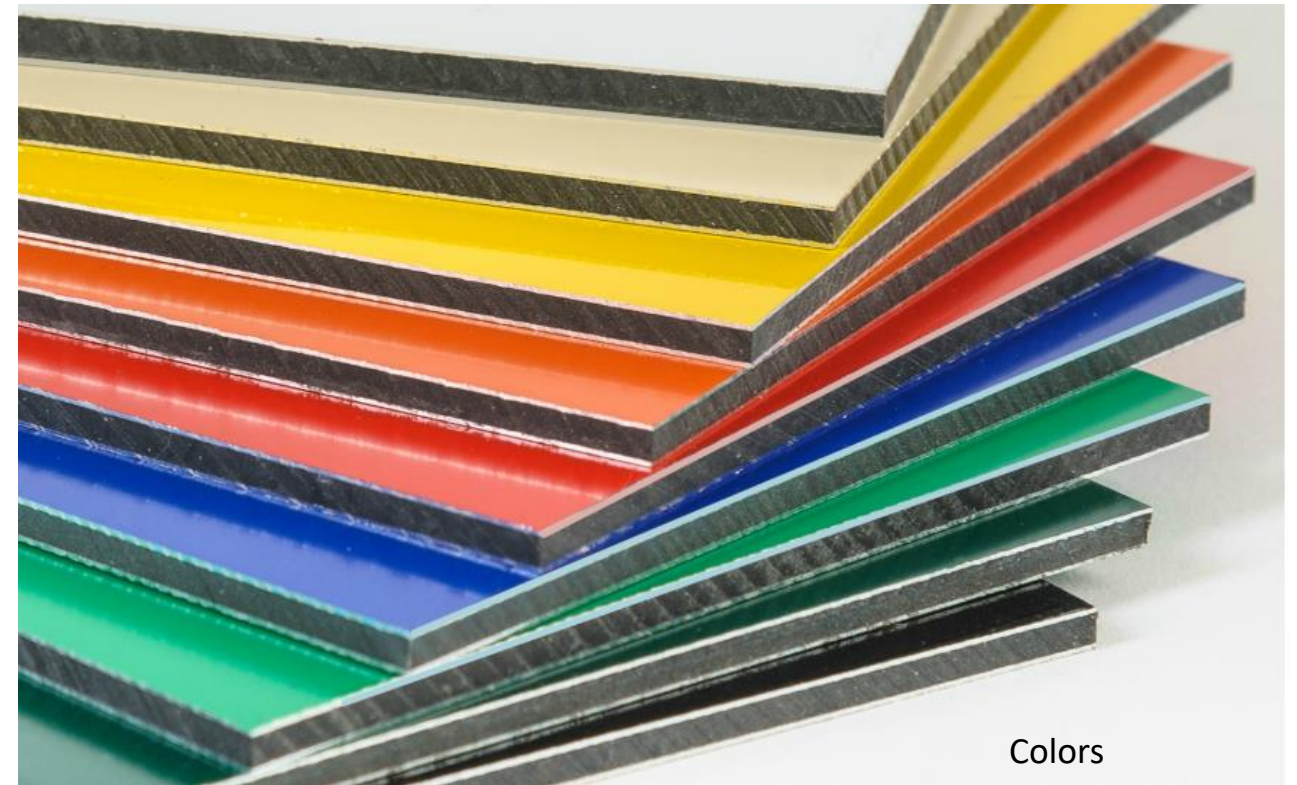

Colors



Textured

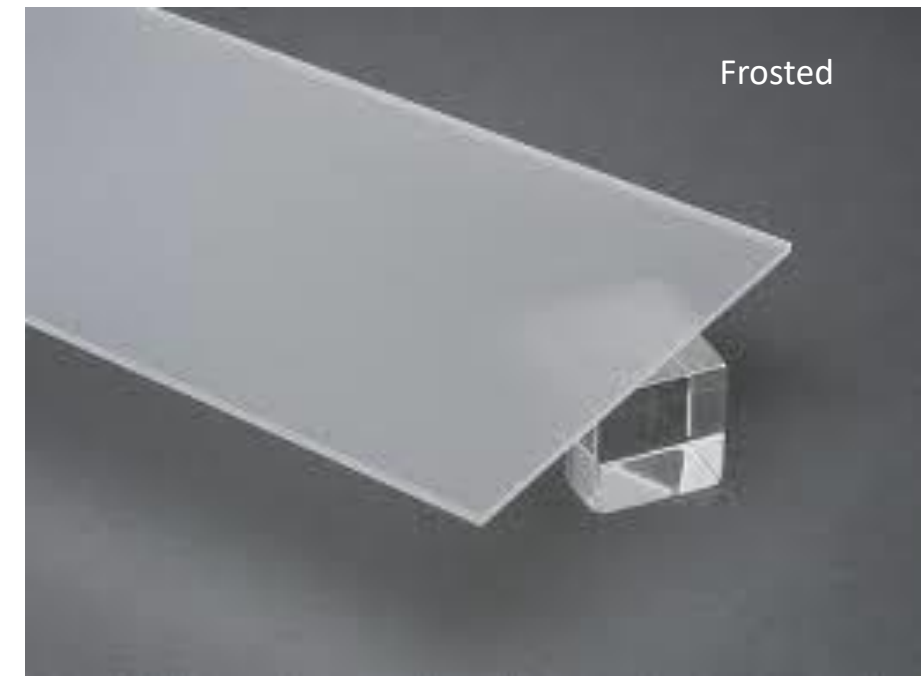

Frosted

We build with the highest quality materials using CNC routers and waterjets for precision and smooth finished edges.

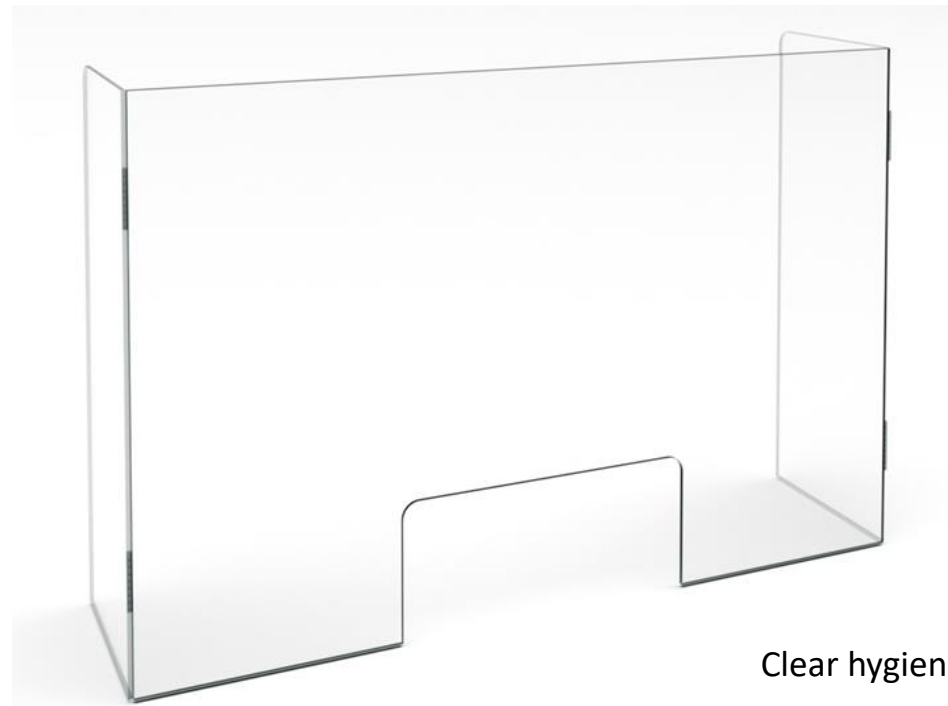

Clear hygiene shields

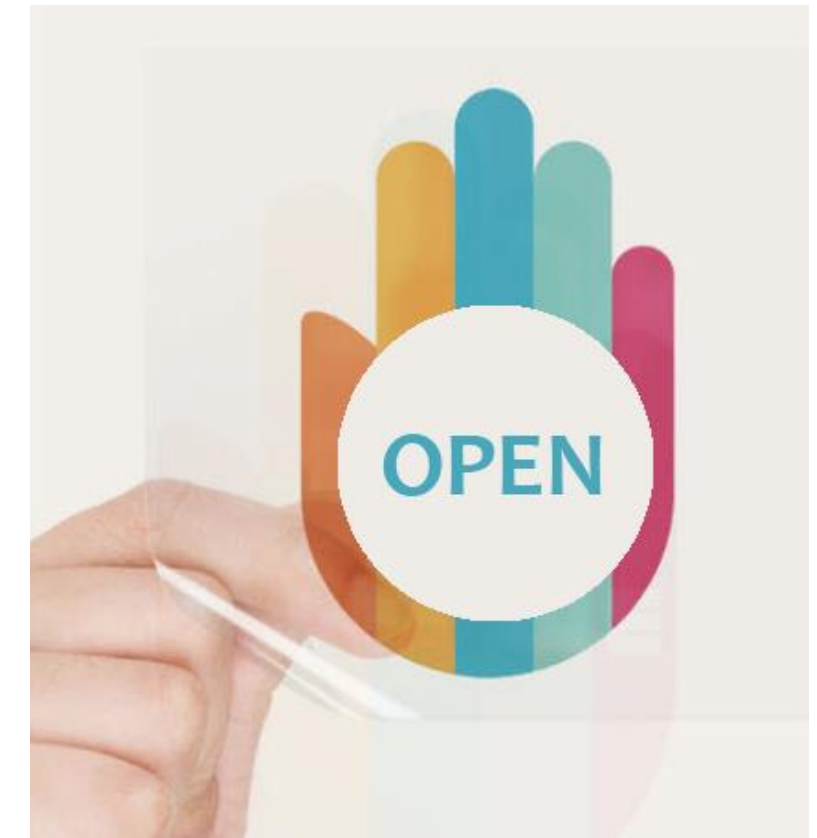

Window clings

Stanchions with and without message



Sanitation stations



Branded direction floor graphics



Please let me know if we can help with your re-opening.
Stay Safe.

STEPHEN PINETTE | Founder and Creative
PEARL STUDIO 82 Inc. | A 3D Design & Innovation Studio
163 Main Street | Suite 4 | Medway, MA 02053
508 533 5582 studio | 617 335 4271 cell | ps82.com